

Year 9 mathematics test

Paper 2

Calculator allowed

First name _____

Last name _____

Class _____

Date _____

Please read this page, but do not open your booklet until your teacher tells you to start. Write your name, the name of your class and the date in the spaces above.

Remember:

- The test is 1 hour long.
- You **may** use a calculator for any question in this test.
- You will need: a pen, pencil, rubber, ruler, a pair of compasses and a scientific or graphic calculator.
- Some formulae you might need are on page 2.
- This test starts with easier questions.
- Try to answer all the questions.
- Write all your answers and working on the test paper – do not use any rough paper. Marks may be awarded for working.
- Check your work carefully.
- Ask your teacher if you are not sure what to do.

Instructions

Answers



This means write down your answer or show your working and write down your answer.

Calculators



You **may** use a calculator to answer any question in this test.

Formulae

You might need to use these formulae

Trapezium

$$\text{Area} = \frac{1}{2}(a + b)h$$

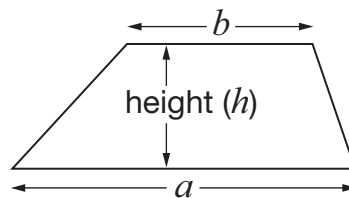

Prism

area of cross-section

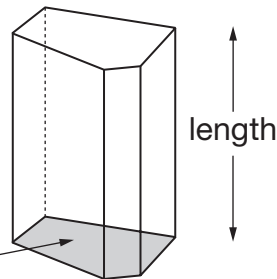

$$\text{Volume} = \text{area of cross-section} \times \text{length}$$

1. Sam has these digit cards.

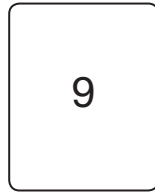
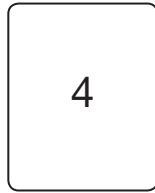

He is going to use each card **once** to make a 3-digit number.

What 3-digit numbers **greater than 750** can Sam make?

Write them all.



2 marks



2. Here are two shapes.

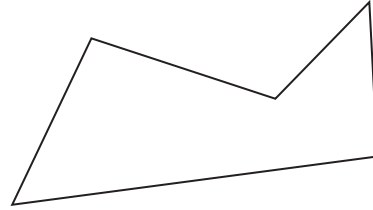
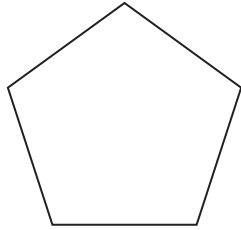

(a) Are both shapes **pentagons**?



Yes

No

Explain how you know.



1 mark

(b) Are both shapes **regular**?



Yes

No

Explain how you know.



1 mark

3. There are two different ways of making **30p** with 10p and 20p coins.

Total 30p	
10p coins	20p coins
3	0
1	1

Complete the table below to show **all five** ways of making **80p** with 10p and 20p coins.

Total 80p	
10p coins	20p coins

2 marks



4. This diagram shows all the **factors** of 10

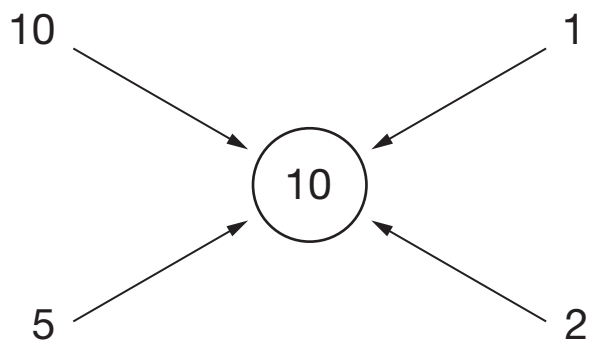

Draw a diagram to show all the factors of 12



2 marks

5. A website gives this information about the five longest rivers in the UK.

	Length (km)
Severn	354
Thames	346
Trent	297
Aire	259
Great Ouse	230

- (a) How many of these rivers are **300 km** to the **nearest 100 km**?



1 mark

- (b) The longest river in the world is the Nile.

Its length is **6695 km**.

Write the missing number in the sentence below.



The length of the Nile is **7000 km** to the nearest _____ km.

1 mark



6. You are a travel agent.

You find these costs of flights for the Jones family.

<p>QP Airlines </p> <hr/> <p>Ticket prices (includes all taxes, fees and charges)</p> <p>Adult: £240</p> <p>Children aged 1 to 12: 50% of the adult price</p> <p>Children under 1: 10% of the adult price</p> <p>1 or 2 suitcases per person: no charge</p>	<p>Budget Air</p> <hr/> <p>Ticket prices (includes all taxes, fees and charges)</p> <p>Adults and children over 1: £185</p> <p>Children under the age of 1: £20</p> <p>Each suitcase: £8</p>
--	---

Mr Jones is 41 years old and so is Mrs Jones.

Kali Jones is 8 years old, Xena Jones is 4 years old and
Roxy Jones is 6 months old.

In total, the family want to take 3 suitcases with them.

Which airline do you recommend and why?



3 marks

7. The table shows the times of high tides at Liverpool on some dates in 2005.

Date in September							
1st	2nd	3rd	4th	5th	6th	7th	8th
09:55	10:30	11:01	11:30	12:00	00:12	00:40	01:09
22:09	22:42	23:13	23:43	–	12:28	12:58	13:29

- (a) At what time was the **first** high tide on **4th** September?



_____ : _____

1 mark

- (b) On what date was there **only one high tide**?



1 mark

- (c) On what date was there a high tide at **13 minutes past 11** in the evening?



1 mark



8. Here are two triangles.

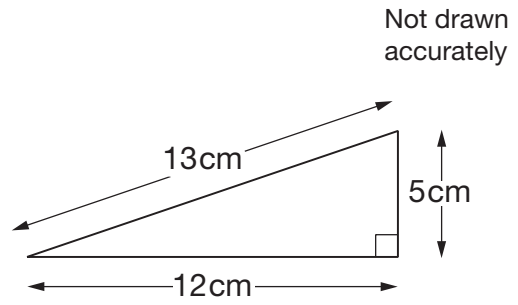
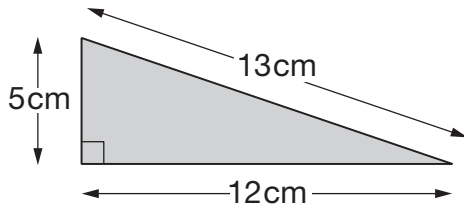

The triangles fit together in different ways to make larger shapes.

Write the perimeter of each larger shape below.

The first one is done for you.

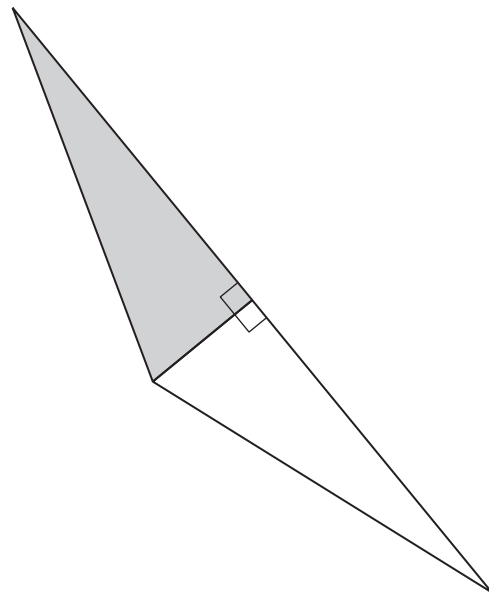
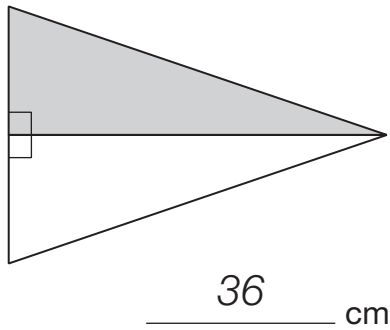

_____ cm

1 mark

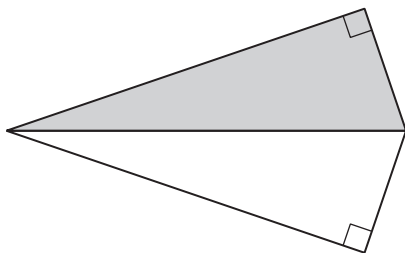

_____ cm

1 mark

9. Here are some headlines from newspapers.

50% want new hospital

Recycling up by 50%

Broadband access now 50%

Passenger numbers up by 50%

Income drops by 50%

All these headlines use '50%'

Explain what 50% means.



1 mark



10. A shop sells fruit.



Peaches
49p each



Oranges
26p each



Apples
£1.50 per kg
1kg is about 5 apples



Bananas
85p per kg
1kg is about 6 bananas



Satsumas
£1.99 per kg
1kg is about 8 satsumas







Alice wants **2 different** fruits.

She has **80p**.

What can she buy?

Complete the table opposite to show different combinations and the change due.

One has been done for you.

What she can buy	Working	Change
1 <u> <i>peach</i> </u> and 1 <u> <i>orange</i> </u>	$49p + 26p = 75p$	5p
1 <u> <i>orange</i> </u> and 1 <u> <i>apple</i> </u>		
 1 _____ and 1 _____		
 1 _____ and 1 _____		
 1 _____ and 1 _____		
 1 _____ and 1 _____		_____ _____ _____

4 marks



11. Here are four spinners, labelled A, B, C and D.

I am going to spin each pointer.

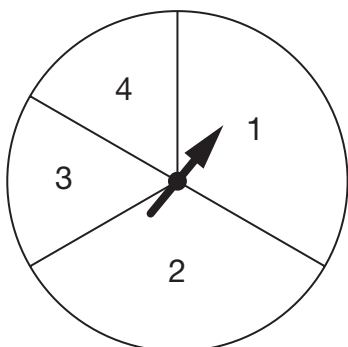

A

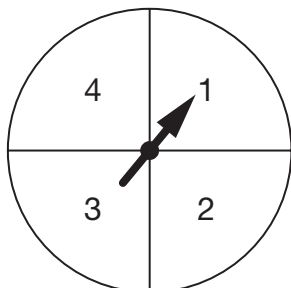

B

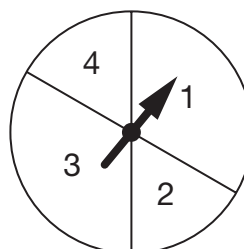

C

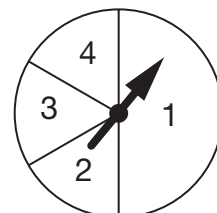

D

- (a) Which spinner gives the **greatest chance** that the pointer will stop on **3**?



Spinner _____

1 mark

- (b) Which spinner gives the **least chance** that the pointer will stop on **1**?



Spinner _____

1 mark

- (c) This spinner is divided into eight equal sectors.

Write a number in each sector so that there is a **50% chance** that the pointer will stop on **2**

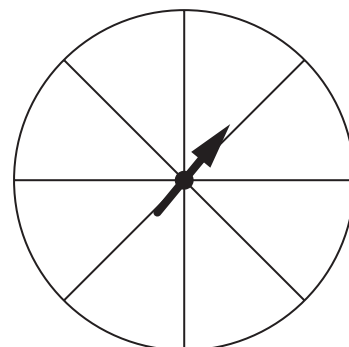

1 mark

12. Jim's clock shows:

<div style="border: 1px solid black; padding: 5px; display: inline-block; font-family: monospace; font-size: 2em;">22 : 00</div>	15 November
--	-------------

What will Jim's clock show in exactly **3 hours** time?

<div style="border: 1px solid black; width: 100px; height: 40px; display: flex; align-items: center; justify-content: center; margin: 0 auto;"> : </div>	<div style="border-bottom: 1px solid black; width: 50px; display: inline-block; margin-right: 5px;"></div> November
---	---

2 marks

13. Write numbers to make these calculations correct.

The first one is done for you.

21	÷	5	=	4 remainder 1
----	---	---	---	---------------

		÷	8	=	4 remainder 2
--	--	---	---	---	---------------

1 mark

		÷		=	4 remainder 3
--	--	---	--	---	---------------

1 mark



14. A website gives this chart to show the chair and table heights for children.

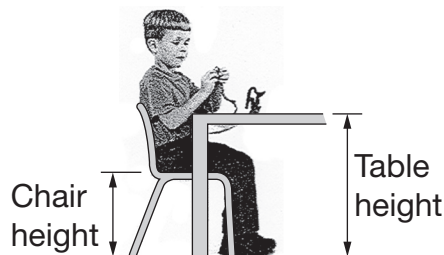

Chair height (inches)	10	12	14	16
Table height (inches)	18	20	22	24–26
4 year-olds	40%	60%		
5 year-olds		100%		
6 year-olds		50%	50%	
7 year-olds		20%	80%	
8 year-olds			80%	20%
9 year-olds			40%	60%
10 year-olds				100%

- (a) 50% of **6 year-olds** need a chair height of 12 inches and a table height of 20 inches.

What do the other 50% of 6 year-olds need?



Chair height: _____ inches Table height: _____ inches

1 mark

- (b) Gill says:

More than three-quarters of all **8 year-olds** need a chair height of 14 inches.

Is she correct?



Yes

No

Explain your answer.



1 mark

15. Jack has forgotten his PIN.

He can remember that it is a four-digit number starting with 9 and ending with 3

9	?	?	3
---	---	---	---

He also knows that the first two digits add up to the same as the last two digits.

Write down **all the numbers** that his PIN could be.



2 marks

16. Write the missing values in this table.

y	$2y$	y^2
3	6	
2		
		36

2 marks



17. Kate wants to decorate **all four walls** of a rectangular room.

Here are the dimensions of her room.

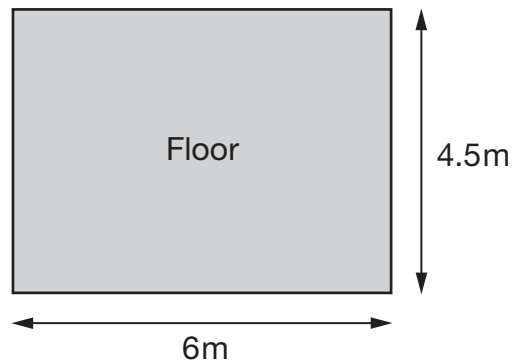

The table shows the number of rolls of wallpaper needed to decorate different sized rooms.

Distance around the room	Number of rolls needed
10m	6
12m	7
14m	8
16m	9

Kate has **11 rolls** of wallpaper.

Does she have enough to wallpaper her room?



Yes

No

Explain your answer.



2 marks

18. For each statement below, tick (✓) the values of n for which the statement is **true**.

The first row is done for you.

	$n = 4$	$n = 5$	$n = 6$	$n = 7$
n is greater than 5			✓	✓
$2n$ is equal to 10				
$2 + n$ is less than 8				
n^2 is less than 30				

2 marks

19. In a triangle, the largest angle is **20 degrees larger** than the smallest angle.

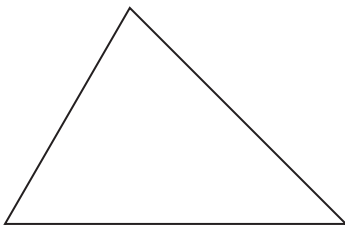

Not drawn accurately

Write down what the three angles could be for this triangle.

○	○	○
---	---	---

2 marks



20. This large rectangle is made from white squares and smaller grey squares.

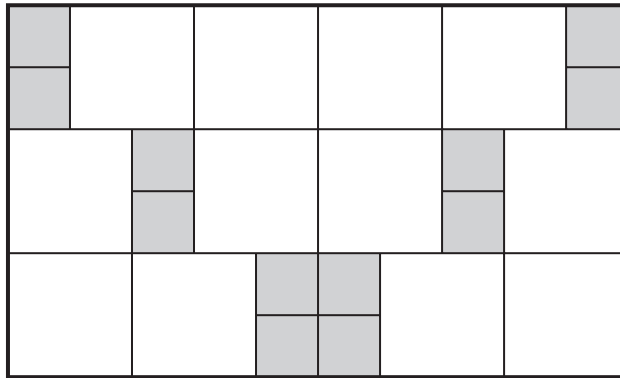

Not drawn
full size

The area of one **grey** square is 1cm^2

What is the area of the large rectangle?



_____ cm^2

2 marks

21. Write the missing numbers in the boxes.

 $0.06 + \boxed{} = 1$

1 mark

 $0.6 + 0.06 + \boxed{} = 1$

1 mark

22. A swimming pool has this price list.

Swimming Pool Price List

	Price	
	Adult	Child
Annual Membership	£230.00	£180.00
Monthly Membership	£26.50	£15.00
Casual Swim	£3.50	£1.65
Add-on Membership	£7.00 for each child	
Family Swim	£7.25	

Annual Membership: Unlimited swimming for a year.
Monthly Membership: Unlimited swimming for one month.
Add-on Membership: Add up to 3 children to an adult Monthly Membership.
Family Swim: 2 adults and 2 children. Pay on entry.

A father and his two children want to swim twice a week for a year.

What is the **minimum** cost **per month** for them to do this?



£	per month
---	-----------

3 marks



23. The diagram shows a rectangle.
The dotted line is a diagonal of the rectangle.

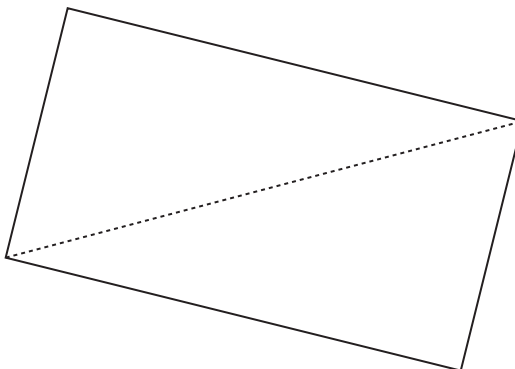

Below is a diagonal of a different rectangle.

The dimensions of the rectangle are **6cm by 8cm**.

Use a pair of compasses and a ruler to draw the rectangle.

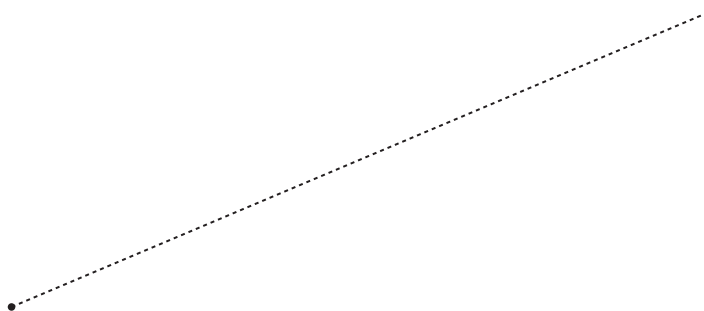

2 marks

24. A word game has tiles with letters on.
Some letters are more common than others.

- (a) There are **100 tiles** in the English version of the game.

Here is information about how many tiles show the letter A, E or O.



9 tiles



12 tiles



8 tiles

I am going to take one of the 100 tiles at random.

What is the **probability** that it will show one of the letters A, E or O?



1 mark

- (b) There are **104 tiles** in the Russian version of the game.

The probability that a tile taken at random will show A, E or O is $\frac{1}{4}$

The ratio of tiles showing A, E or O is **4 : 4 : 5**

Work out how many of the 104 tiles show the letters A, E or O.



_____ tiles



_____ tiles



_____ tiles

2 marks



25. I have **16 cubes** that are all the same size.
I join the 16 cubes together to make the cuboid shown below.

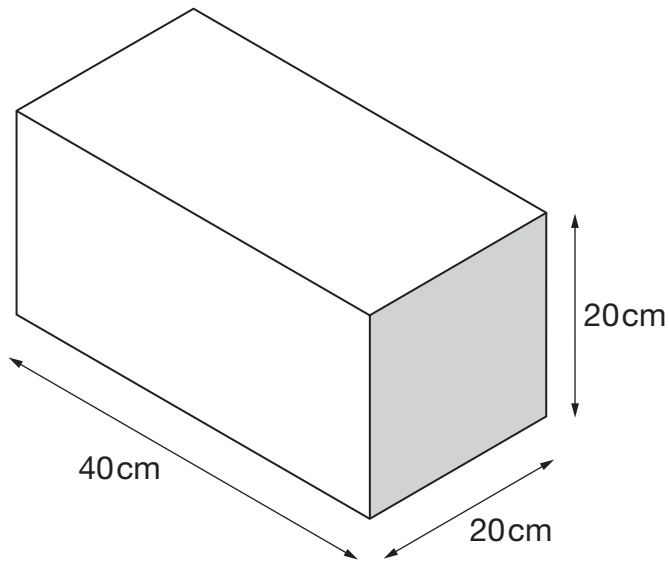

Not drawn
accurately

What is the **side length** of one of my cubes?



_____ cm

2 marks

26. The diagrams show how the average height of a 7 year-old child in China changed from 1957 to 2007.

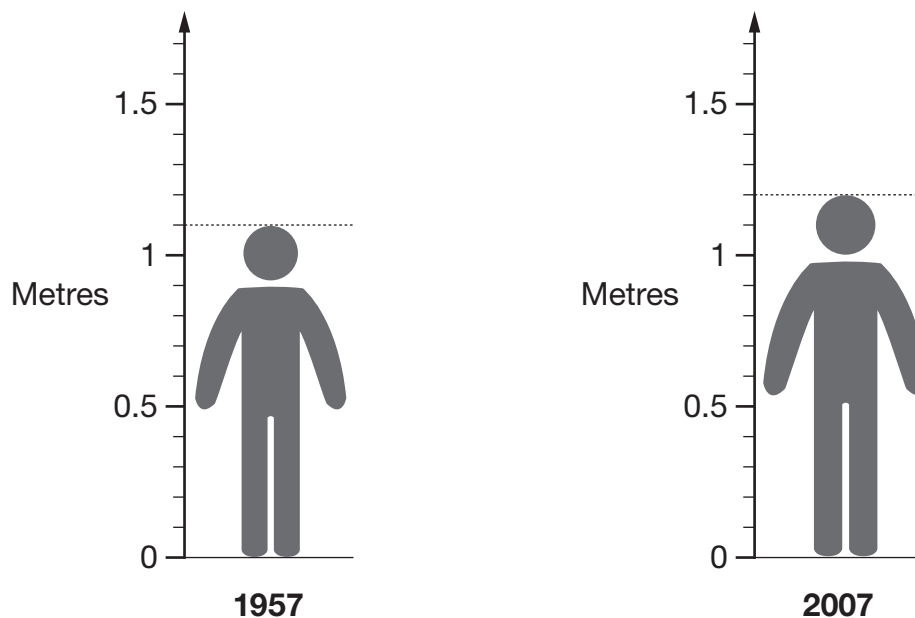

- (a) The average height of a 7 year-old child in China has increased over these 50 years. By how many **centimetres per year** has it increased?



cm per year

1 mark

- (b) In 2007, the average height of a woman in China was **30% more** than the average height of a 7 year-old child.

What was the average height of a woman in China in 2007?



m

2 marks



27. Look at the diagram.
- The square has a side length of 7cm.
- The circle fits exactly inside the square.

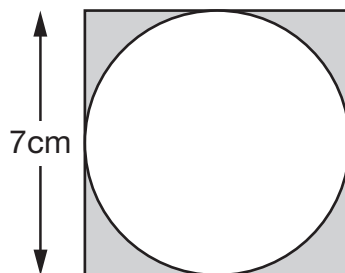

Not drawn
accurately

Work out the area of the circle.



_____ cm^2

1 mark

END OF TEST



BLANK PAGE